

Delock Shield Clamp for DIN Rail - Cable diameter 3 - 8 mm

Description

With this shield clamp by Delock a cable with a diameter of 3 - 8 mm can be attached to a 35 mm DIN rail. The clamp can also be used as an EMC shield. In this case, unwanted electrical or electromagnetic effects are dissipated from the DIN rail.

Application

To fasten a cable to the clamp, the spring must be pressed down with a tool, e.g. a screwdriver. If a cable is attached to the clamp, the best way to detach it is to press the spring down with the cable. The shield clamp can also be screwed to the DIN rail, for which an Allen key size HX3 is required.

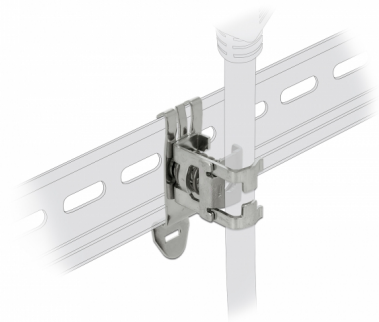

Item no. 66440

EAN: 4043619664405

Country of origin:
Germany

Package: Zip poly bag

Technical details

- DIN rail mounting: 35 mm
- Cable diameter:
min.: 3 mm
max.: 8 mm
- Material: metal
- Dimensions (LxWxH): ca. 26 x 18 x 14 mm

System requirements

- 35 mm DIN rail

Package content

- Shield clamp

Images



General

Mounting type:	DIN rail mounting: 35 mm
----------------	--------------------------

Physical characteristics

Material:	metal
Length:	26 mm
Width:	18 mm
Height:	14 mm
Cable diameter:	min.: 3 mm max.: 8 mm