

Delock SATA 6 Gb/s DOM Module 64 GB MLC SATA Pin 8 power

Description

This SATA DOM module by Delock is especially suitable for use in industrial PCs und Server.

Advantage: No additional power supply is required as power is provided via the SATA pin 8 connector. To use this application, a motherboard with SATA pin 8 connector is needed. The SATA pin 8 connector on the motherboard is of yellow colour. If no SATA pin 8 connector is available, this module can also be used via the standard SATA connector. For this purpose, the power supply is provided via the 3 pin power connector.



64 GB

Item no. 54776

EAN: 4043619547760

Country of origin: Taiwan, Republic Of China

Package: Antistatic cover

Schematic representation for SATA Pin 8

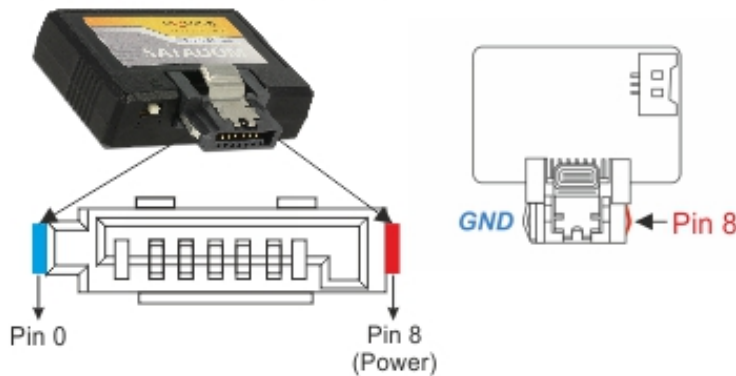

Standard power supply



Technical details

- Capacity: 64 GB
- Interface: SATA 6 Gb/s
- Supports SATA pin 8 power
- Chip: Toshiba
- Flash type: MLC
- Maximum performance: 540 MB/s read, 90 MB/s write
- Maximum write cycles: 3000
- Maximum power consumption: 2.39 W (5 V x 478 mA)
- Write protect: yes
- ATA security: yes
- S.M.A.R.T.: yes
- Thermal sensor: no
- Dimensions (width x length x height): 37.17 x 31.50 x 10.20 mm
- Vibration: 20G @ 7 ~ 2000 Hz
- Shock: 1500G @ 0.5 ms
- MTBF: >3 million hours
- Operation temperature: 0 °C ~ 70 °C
- Storage temperature: -55 °C ~ 95 °C

System requirements

- A free SATA 8 pin or SATA 7 pin connector
- For SATA 7 pin: power supply with a free 4 pin power connection

Package content

- SATA DOM module
- Power cable

Images

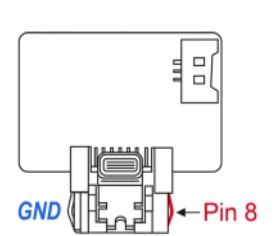
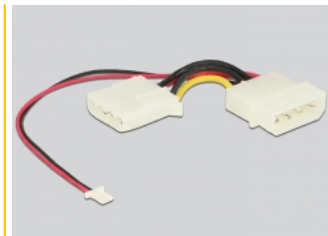
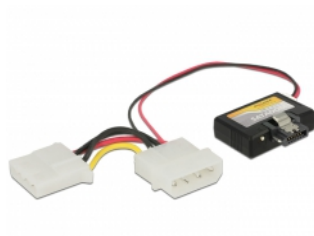

Technical characteristics

Chipset:	Toshiba
Storage temperature:	-55°C - 95°C
Read:	540 MB/s
Maximum power consumption:	2.39 W
Maximum write cycles:	3000
MTBF:	3 million hours
Interface:	SATA 6.0 Gb/s
Shock:	1500 G @ 0.5 ms
Write:	90 MB/s
Write protect:	yes
Capacity:	64 GB
Thermal sensor:	yes
Vibration:	20 G @ 7 ~ 2000 Hz
Password protection:	Yes

Physical characteristics

Length:	31.50 mm
Width:	37.17 mm
Height:	10.20 mm